

F012 935 232

Issue | 10-12-07

Stand | 11-03-29

**Fig./Abb. 1**

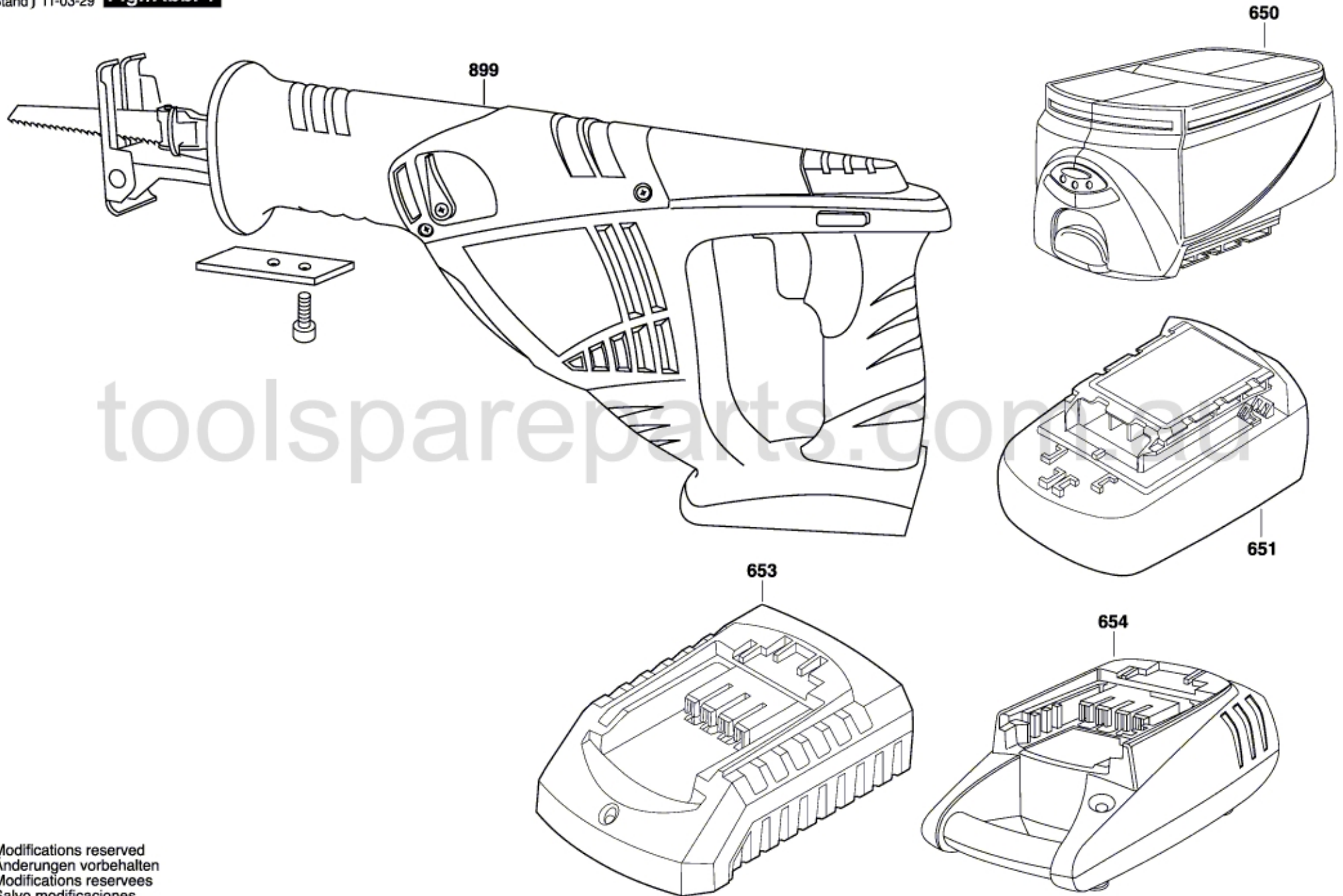

Modifications reserved  
Änderungen vorbehalten  
Modifications reserves  
Salvo modificaciones